

PRODUCT DATASHEET

DL SLIM SQ 105 6 W 6500 K WT

DOWNLIGHT SLIM SQUARE | Flat downlights with integrated driver, square shape



Areas of application

- Direct replacement for luminaires with compact fluorescent lamps
- General illumination
- Public areas
- Stairways
- Corridors
- Foyers
- Shops

Product benefits

- Very slim housing
- Low installation depth
- High luminous efficacy
- Energy savings up to 60 % (compared to luminaires that use CFL lamps)
- Very homogenous light
- Functional design
- Easy installation with fast connection
- Simple installation thanks to integrated driver

Product features

- Small visible bezel
- Connector box with push wire terminal for tool-free connection



- Light guide made of non-yellowing PMMA for long lifetime

TECHNICAL DATA

Electrical data

Nominal wattage	6.00 W
Nominal voltage	220...240 V
Mains frequency	50...60 Hz
Nominal current	58 mA
Inrush current	6 A
Inrush current time T_{h50}	120 μ s
Max. number of luminaires per miniature circuit breaker B16	72
Max. number of luminaires per miniature circuit breaker C10	60
Max. number of luminaires per miniature circuit breaker C16	96
Power factor λ	0.50
Total harmonic distortion	< 20 %
Protection class	II
Operating mode	Integrated LED driver

Photometrical data

Luminous flux	430 lm
Luminous efficacy	70 lm/W
Color temperature	6500 K
Light color (designation)	Cool Daylight
Color rendering index Ra	> 80
Standard deviation of color matching	< 6 sdc _m
Luminous intensity	-
Flickering metric (Pst LM)	-
Stroboscope effect metric (SVM)	-
Photobiological safety group acc. to EN62778	RG0
Photobiological safety group acc. to EN62471	RG0
Beam angle	120 °

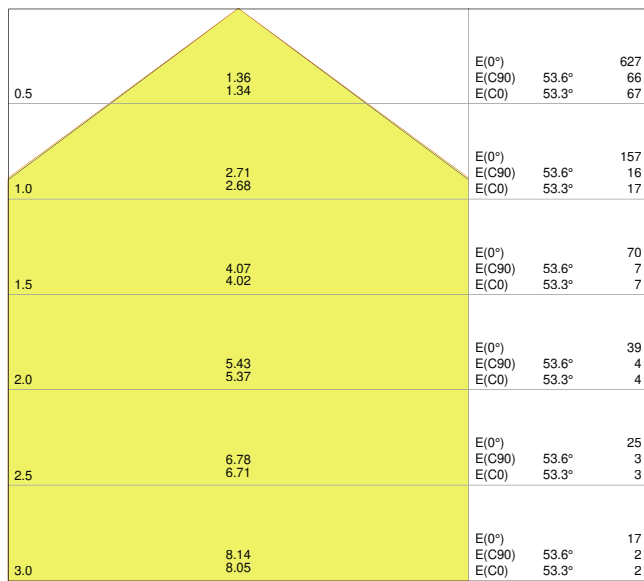

Distance [m] Cone diameter [m] Illuminance [lx]

— C0/C180 (Half beam angle [°]: 106.6°)
— C90/C270 (Half beam angle [°]: 107.2°)

4058075052505 DL SLIM SQ105 6W 6500K WT IP20

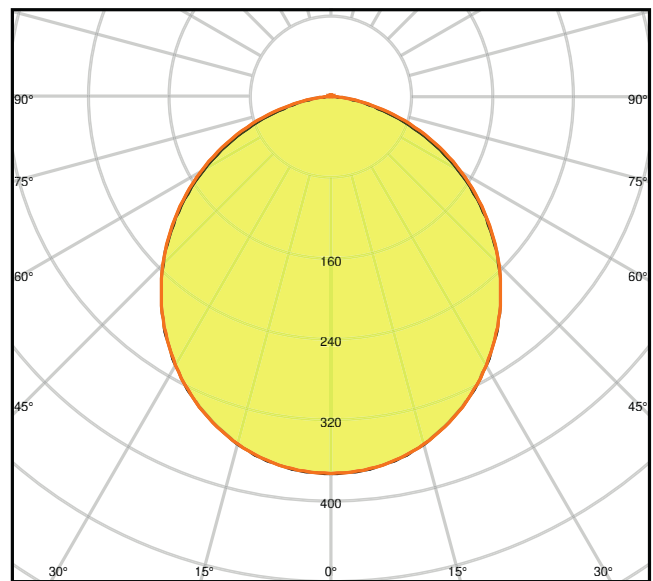

cd/kim η = 100%

— C0/C180
— C90/C270

4058075052505 DL SLIM SQ105 6W 6500K WT IP20

Dimensions & Weight

Length	118.00 mm
Width	118.00 mm
Height	30.00 mm
Product weight	172.00 g

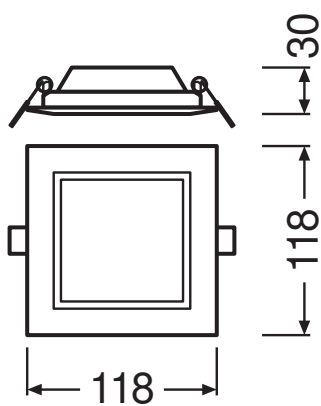

DL Slim SQ105 6W

Materials & Colors

Product color	White
Housing color	White
Body material	Polycarbonate (PC)
Cover material	Polycarbonate (PC)
Light emitting surface material	Polycarbonate (PC)
Glow Wire Test according to IEC 60695-2-12	650 °C
Mercury content	0.0 mg

Application & Mounting

Ambient temperature range	-20...+50 °C
Temperature range at storage	-30...+70 °C
Type of connection	Screwless terminal, 2-Pole
Type of protection	IP20
Protection class IK (shock resistance)	IK03
Dimmable	No
Mounting type	Recessed
Mounting location	Ceiling / Wall
Application environment	Indoor
Mounting length	105.00 mm
Mounting width	105.00 mm
Mounting depth	50,0 mm
LED module replaceable	Not replaceable
With light source	Yes

Lifespan

Lifespan L70/B50 at 25 °C	30000 h ¹⁾
Lifespan L80/B10 at 25 °C	20000 h ¹⁾
Lifespan L90/B10 at 25 °C	12000 h
Number of switching cycles	50000

¹⁾ t[h]: L70 / B50 @ 25 °C (Ta), t[h]: L80 / B10 @ 25 °C (Ta), t[h]: L90 / B10 @ 25 °C (Ta)

Control gear

Output current	180 mA
ECG - Output ripple current	< 6.5 %

Certificates & Standards

Standards	CE / CB / EAC
Luminaire with limited surface temperature, "D sign"	No
Ball shot safe	No

Additional product data

Number of illuminants	Not relevant
-----------------------	--------------







Accessories Optional

Product image	Product name	EAN
	DL SLIM FRAME SQ 105 WT	4058075079397







EQUIPMENT / ACCESSORIES



– Surface mounting frames available as accessories

DOWNLOAD DATA

Documents and certificates		Document name
	Extended installation guide	User Instruction Downlight LED Slim
	On-Pack-Info	Legal Insert Downlight Slim
	Legal information	LSI DL SLIM
	Legal information	Informationstext 18 Abs 4 ElektroG
	Declarations of conformity	CE Certificate downlight Slim
	Declarations Of Conformity UKCA	DL SLIM WT IP20

Photometric and lighting design files		Document name
	IES file (IES)	DL SLIM SQ105 6W 6500K WT IP20

Photometric and lighting design files		Document name
	LDT file (Eulumdat)	DL SLIM SQ105 6W 6500K WT IP20
	ULD file (DIALux)	DOWNLIGHTSLIMSQUARE1056W6500KWT
	ROLF file (RELUX)	DL SLIM SQ105 6W-6500K
	UGR file (UGR table)	4058075052505 DL SLIM SQ105 6W 6500K WT IP20
	LDC typ cone	4058075052505 DL SLIM SQ105 6W 6500K WT IP20
	LDC typ polar	4058075052505 DL SLIM SQ105 6W 6500K WT IP20

CAD/BIM files		Document name
	BIM_Revit_3D	Downlight Slim Square
	CAD_STEP_3D	DL SLIM SQ 105

Tender texts		Document name
	Tender documents	DOWNLIGHT SLIM SQUARE 105 6 W 6500 K WT-EN

LOGISTICAL DATA

Product code	Packaging unit (Pieces/Unit)	Dimensions (length x width x height)	Gross weight	Volume
4058075079250	Folding box 1	45 mm x 145 mm x 145 mm	206.00 g	0.95 dm ³
4058075079267	Shipping box 6	290 mm x 155 mm x 165 mm	1401.00 g	7.42 dm ³

The mentioned product code describes the smallest quantity unit which can be ordered. One shipping unit can contain one or more single products. When placing an order, for the quantity please enter single or multiples of a shipping unit.

References / Links

– For Guarantee see www.ledvance.com/guarantee

DISCLAIMER

Subject to change without notice. Errors and omission excepted. Always make sure to use the most recent release.